

İlk yayın: 1 Eylül 2014

[www.guven-kutay.ch](http://www.guven-kutay.ch)

# YAPI STATİĞİ

## Reaksiyonlar ve kesit büyüklükleri için Aıştırma sonuçları

44-01-3

*M. Güven KUTAY, Muhammet ERDÖL*

*En son durum: 1 Eylül 2014*

Burada verilen sonuçlar, alıştırma çözerken destek olması için verilmiştir. Çözüm yolu ile sonuçlar ayrıca 44-01-4 numaralı dosya ile verilmiştir.

### **DİKKAT:**

*Bu çalışma iyi niyetle ve bugünün teknik imkanlarına göre yapılmıştır. Bu çalışmadaki bilgilerin yanlış kullanılmasından doğacak her türlü maddi ve manevi zarar için sorumluluk kullanana aittir. Bu çalışmadaki bilgileri kullananlara, kullandıkları yerdeki şartları iyi değerlendirip buradaki verilerin yeterli olup olmadığına karar vermeleri ve gerekirse daha detaylı hesap yapmaları önerilir. Eğer herhangi bir düzeltme, tamamlama veya bir arzunuz olursa, hiç çekinmeden bizimle temasa geçebilirsiniz.*

## 1. Basit temel problemler

## 1.1.

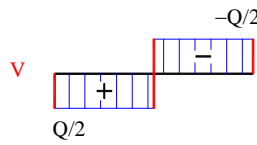
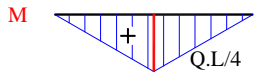
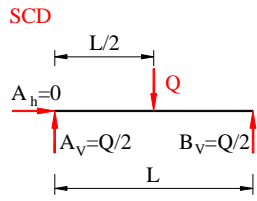

## 1.2.

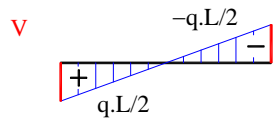
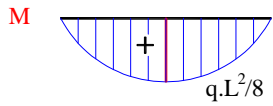
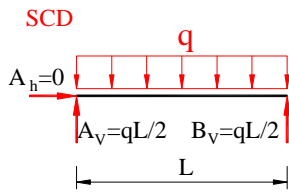

## 1.3.

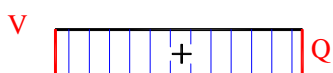
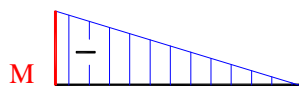
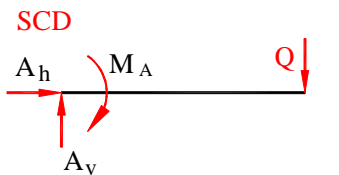

## 1.4.

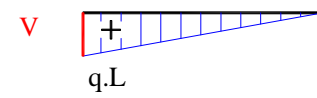
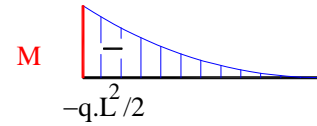
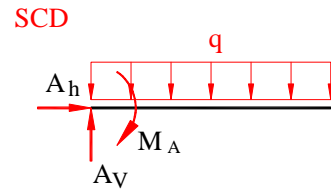

## 1.5.

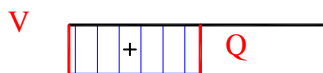
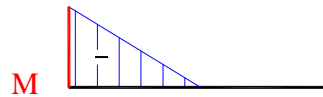
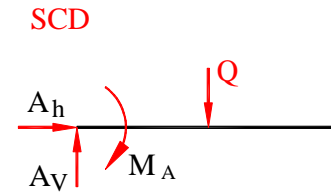

## 1.6.

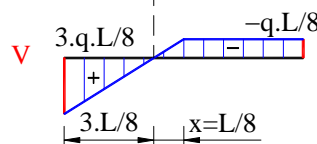
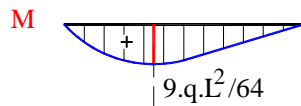
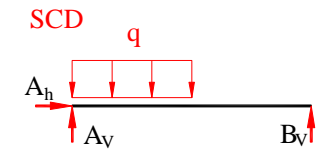

1.7.

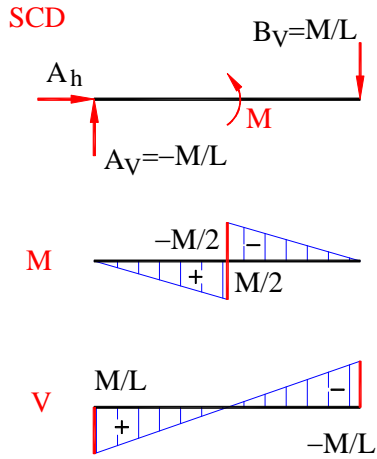

1.8.

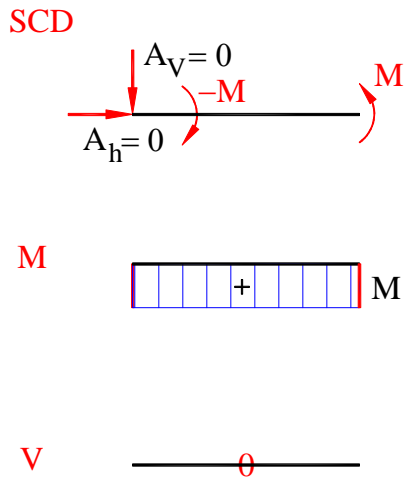

1.9.

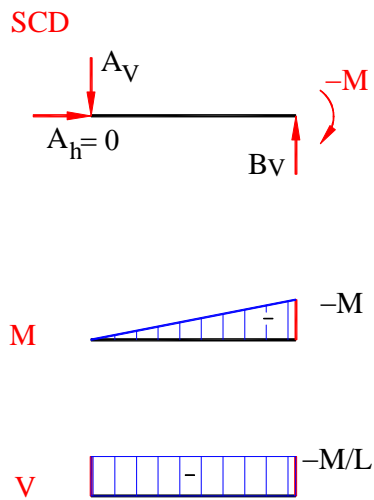

1.10.

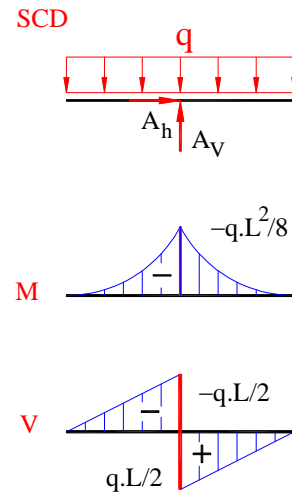

1.11.

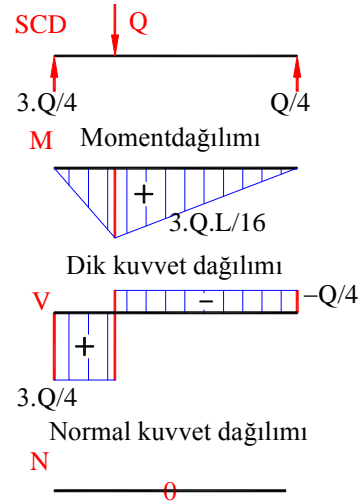

## 2. Karisik problemler

## 2.1.

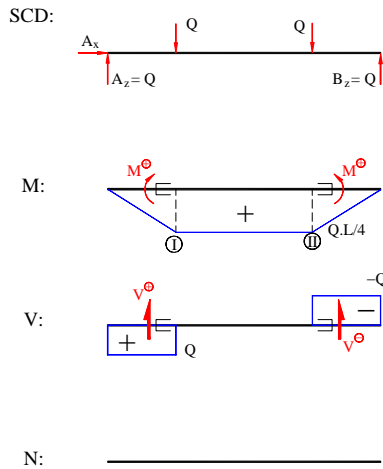

## 2.2.

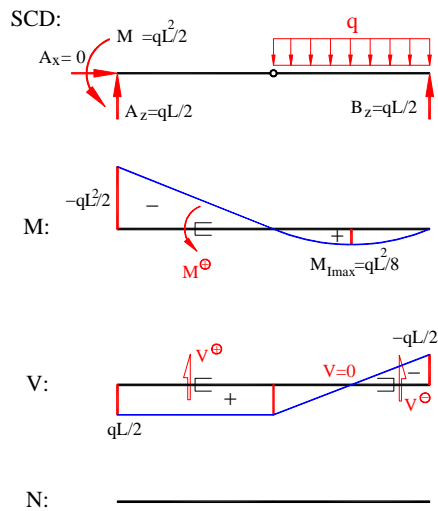

## 2.3.

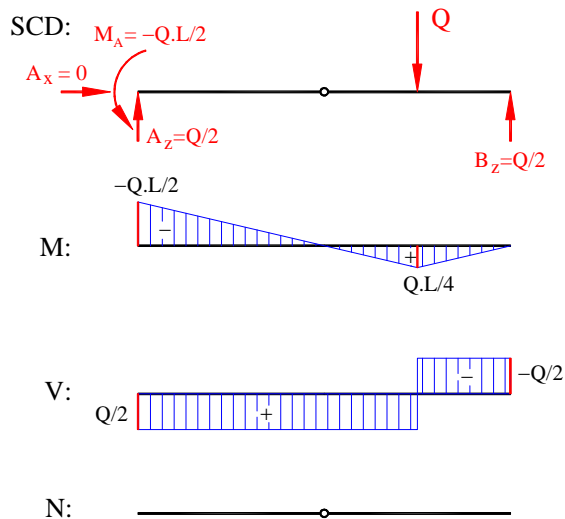

## 2.4.

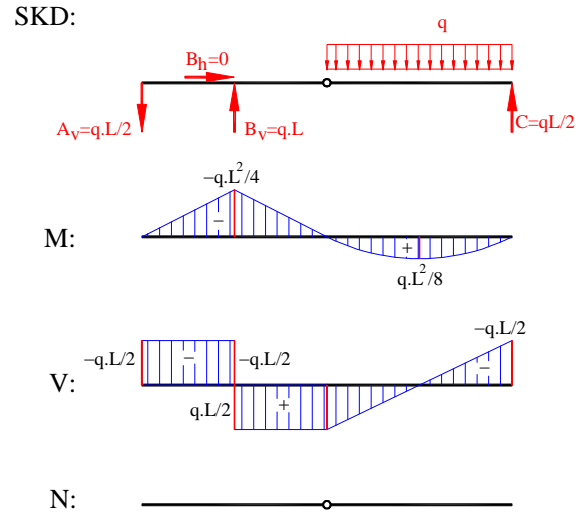

## 2.5.

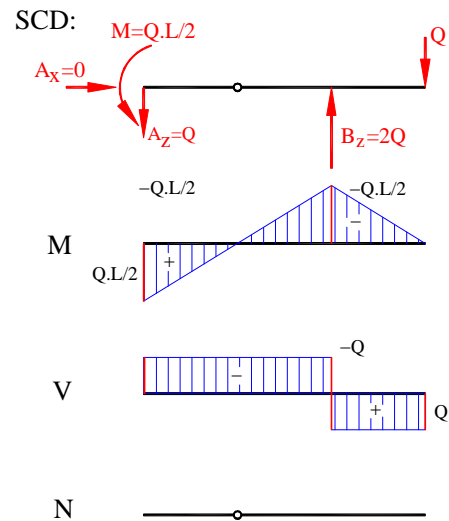

## 2.6.

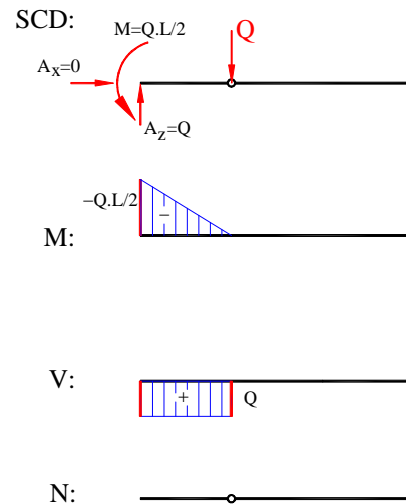

2.7.

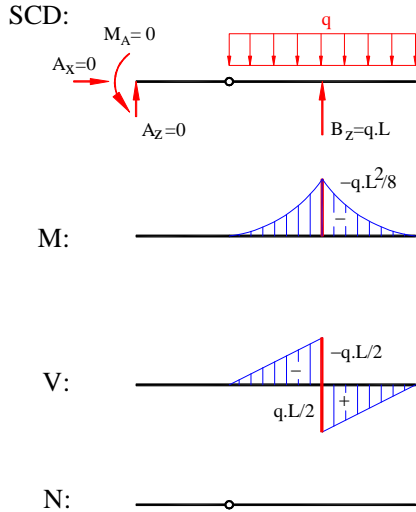

2.8.

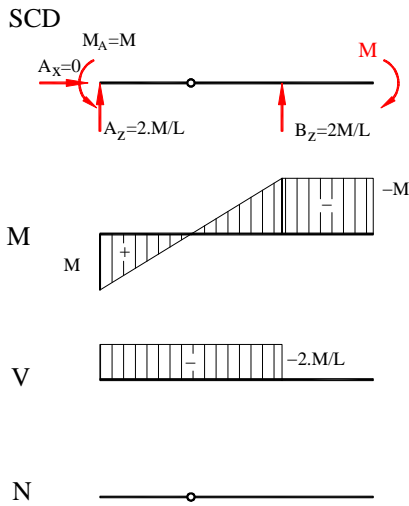

2.9.

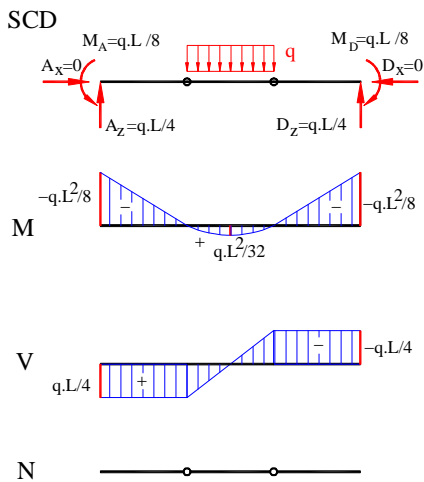

2.10.

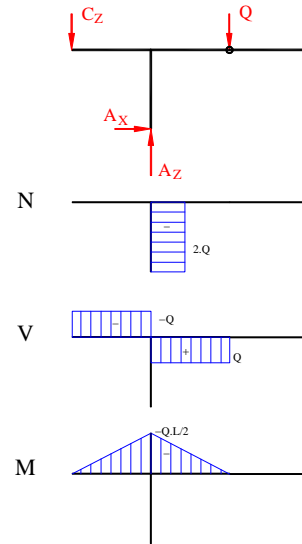

2.11.

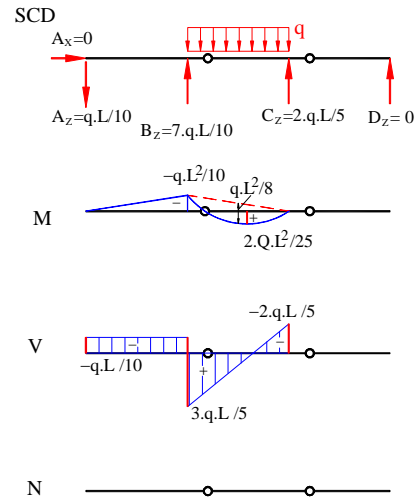

2.12.

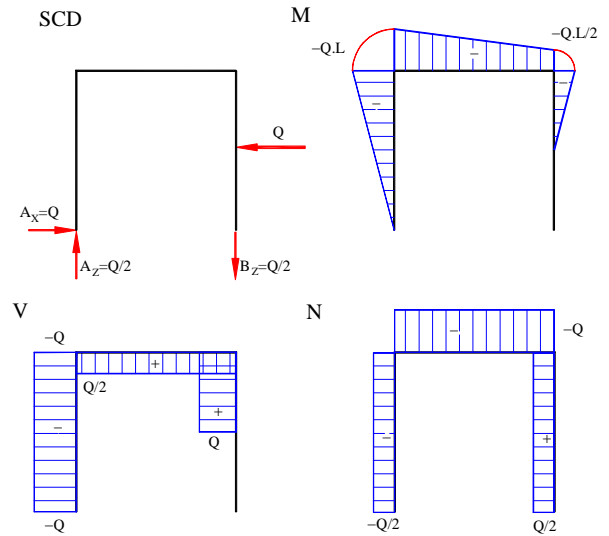

2.13.

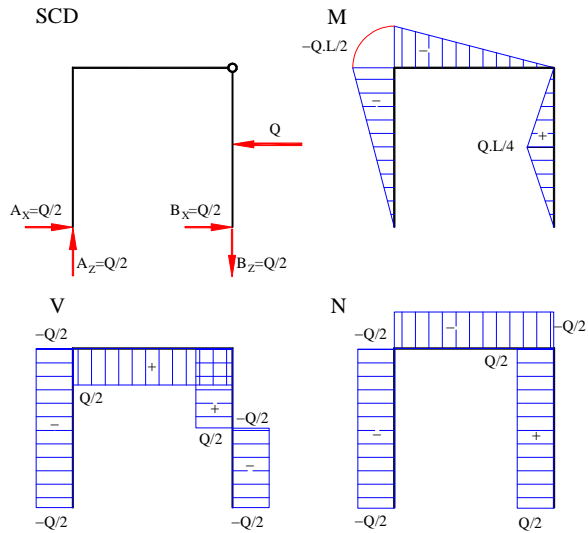

2.14.

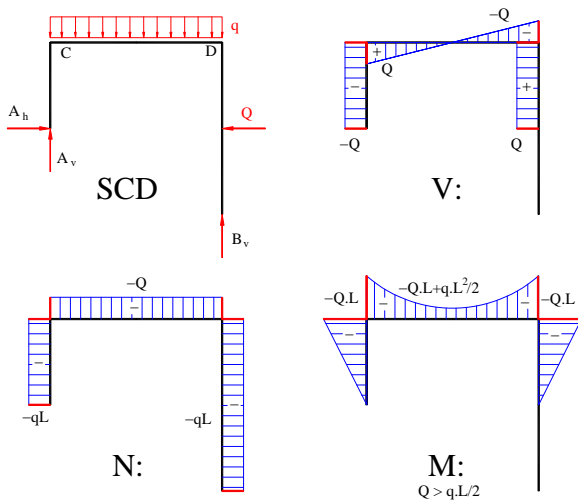

2.15.

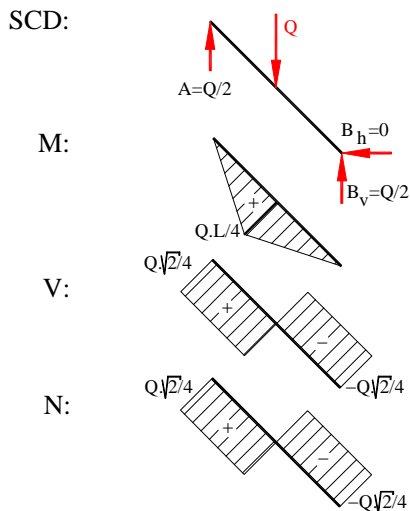

2.16.

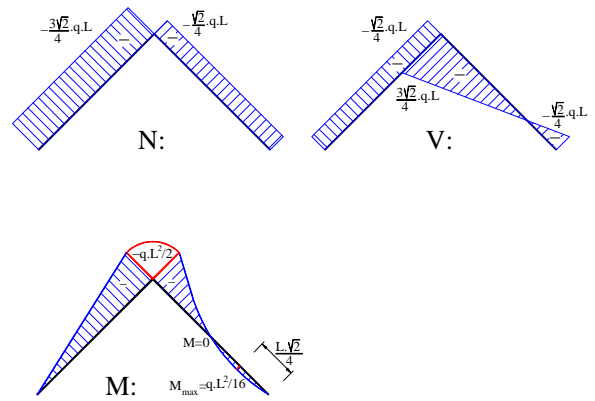

2.17.

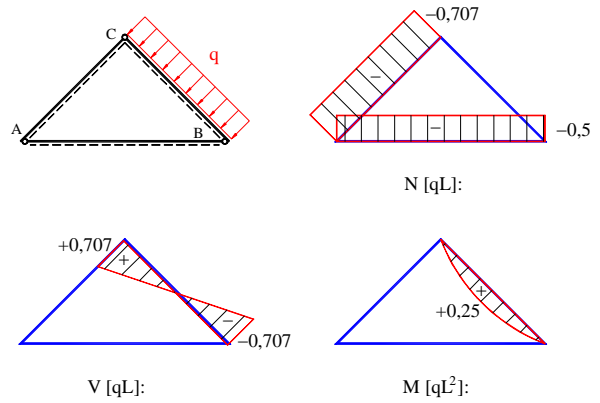

2.18.

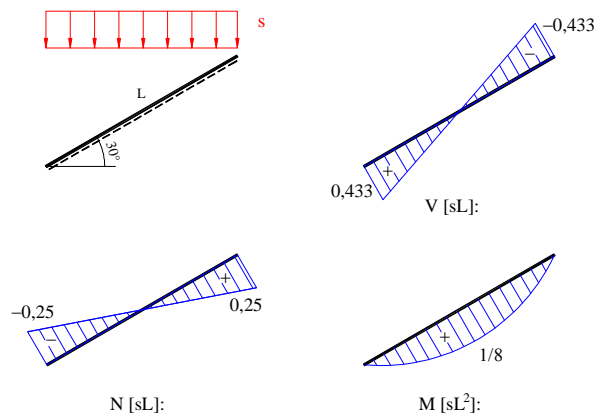

2.19.

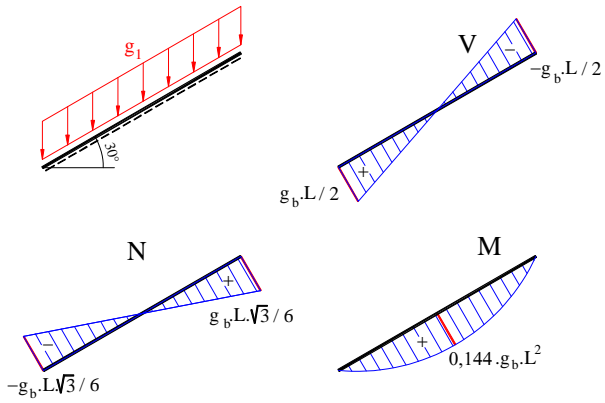

2.20.

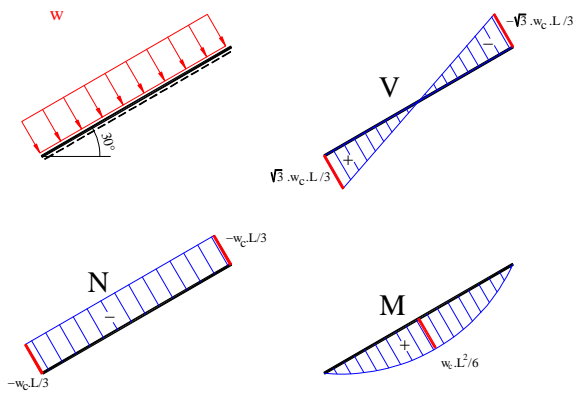

2.21.

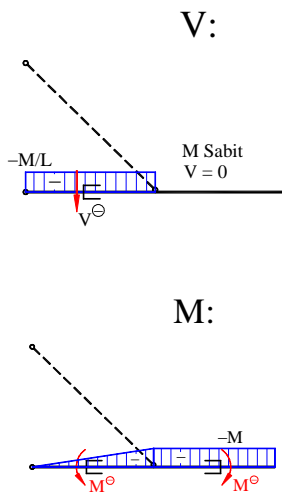

2.22.

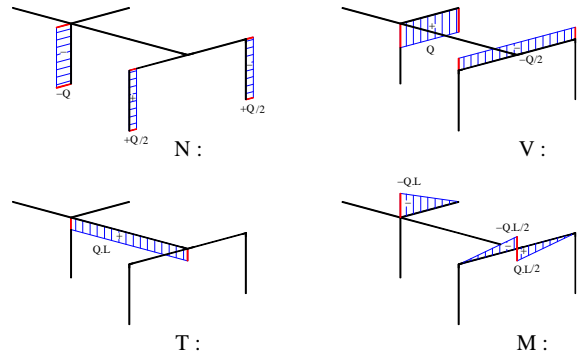
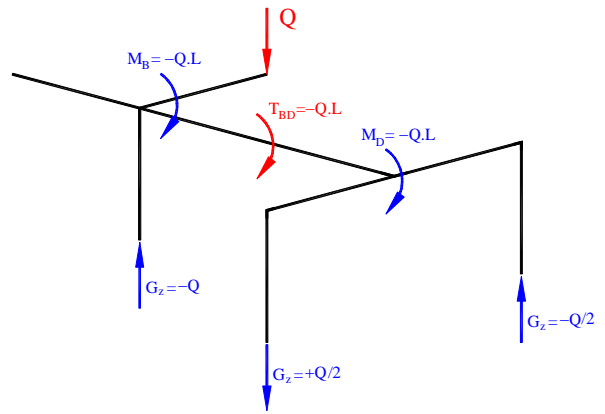

2.23.

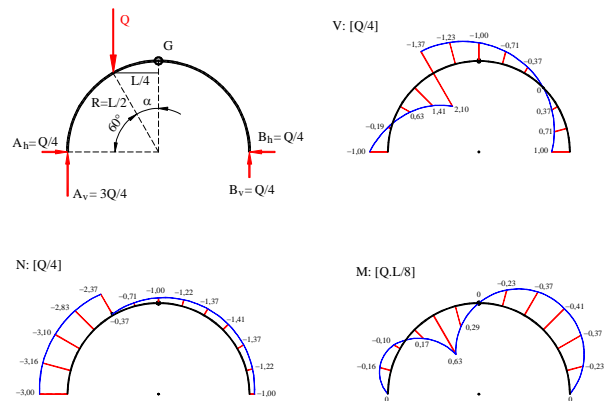

**2.24.**

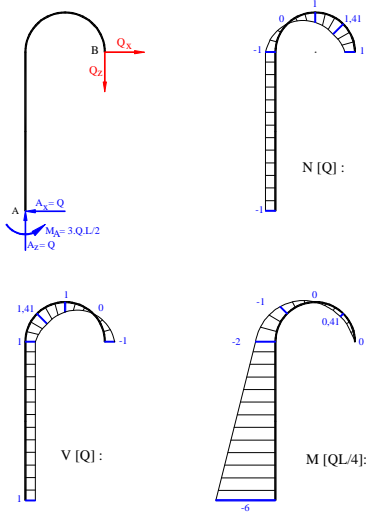

**2.25.**

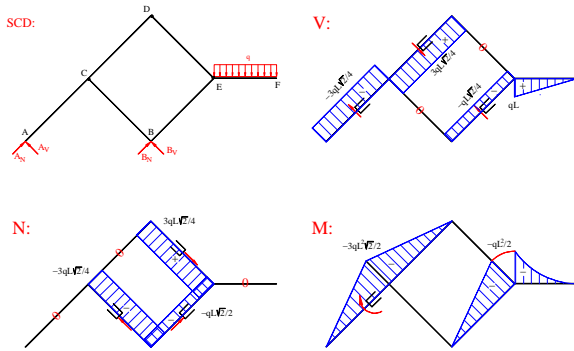

**2.26.**

